

# 340-94



**Features: 340-94**

- 40 US t @ 9ft
- 94 ft maximum boom length
- 102 ft maximum tip height
- Engine power 300 hp
- Electronic rated capacity indicator
- Quick reeve boom head
- Optional 32-49 ft offsettable jib

# CRANE DIMENSIONS

340-94

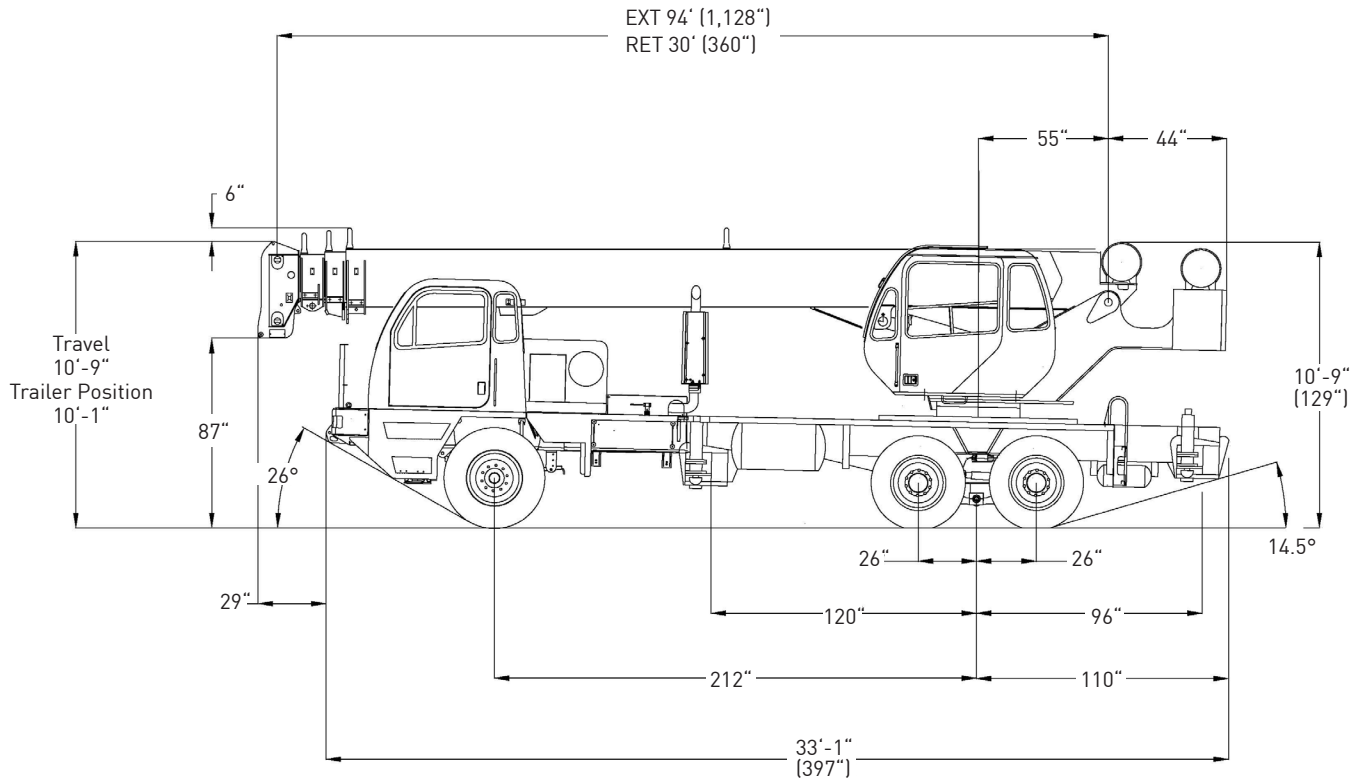

# CRANE DIMENSIONS



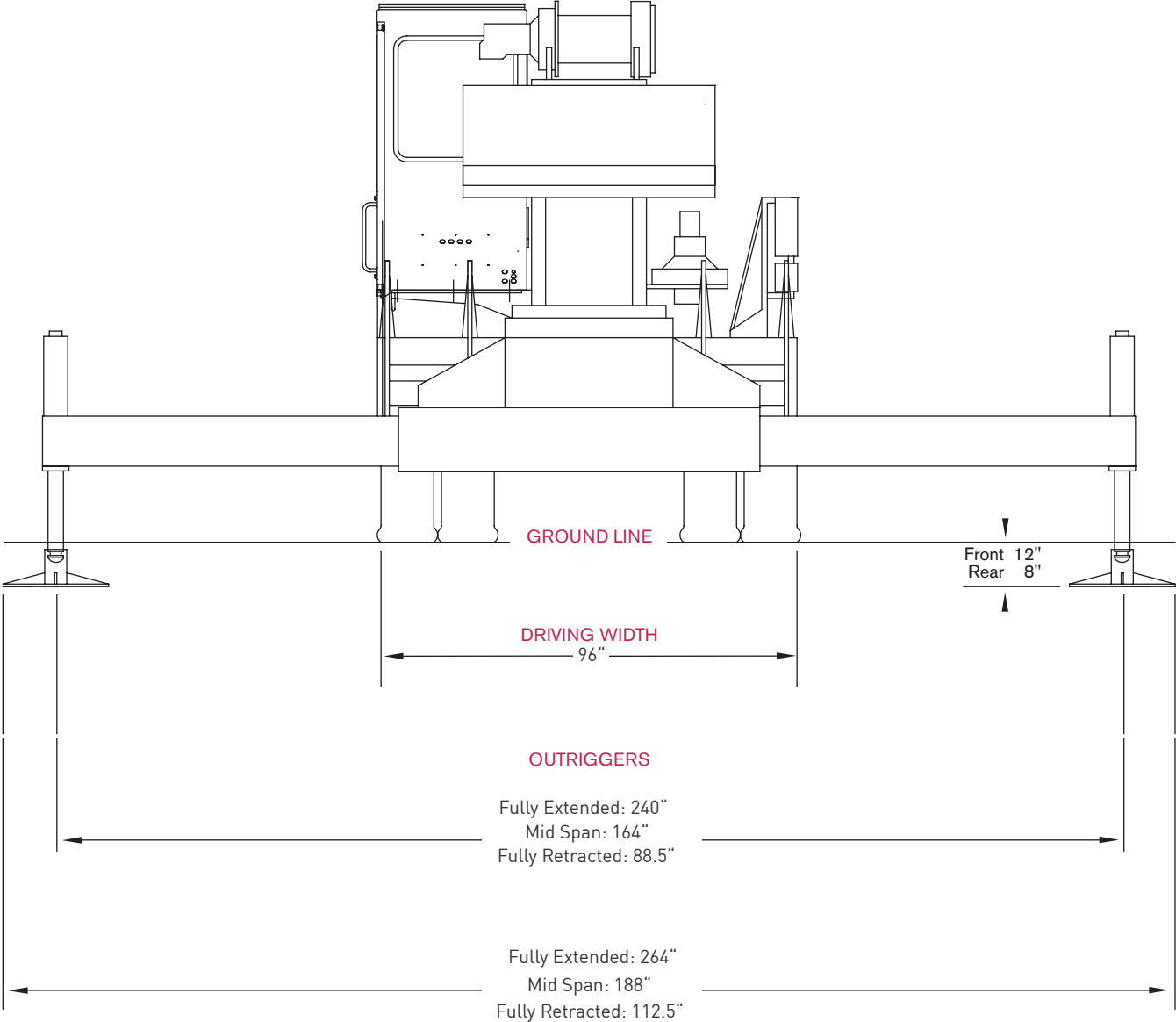





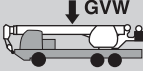
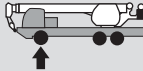
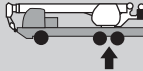

340-94



# SPECIFICATIONS

# 340-94

## Approximate Crane Weights

<b>Boom in front travel position</b>		 Gross Vehicle	 Front max. 22,000 lb	 Rear max. 45,000 lb
Configurations:	<b>340-94</b> 1/4 tank fuel 200 lb operator seated in cab Front tires: 425/65 R22.5 Rear tires: 11R22 94 ft boom/no jib 7,200 lb total counterweight	53,736	15,956	37,780
Add options				
	Full tank of fuel	+ 315	+ 120	+ 195
	Heater/defroster in upper cab	+ 60	- 5	+ 65
	Auxiliary hoist with drum roller and wire rope	+ 175	- 73	+ 248
	Electric remote control	+ 200	+ 100	+ 100
	32 ft swing-on jib - 94' boom	+ 1,368	+ 797	+ 571
	32 ft to 49 ft extendable swing-on jib - 94' boom	+ 1,789	+ 1,007	+ 785
	Auxiliary boom head - 94' boom	+ 100	+ 154	- 54
	40 USt hook block on bumper 25 USt 2 Sheave 30 USt 3 Sheave 30 USt 4 Sheave	+ 690	+ 973	- 283
	7 USt hook and ball at bottom rack 12 USt hook and ball at bottom rack	+ 240	+ 145	+ 95
	Spin resistant wire rope (per winch)	+ 32	- 12	+ 44

# RANGE DIAGRAM - MAIN BOOM

340-94

## Outriggers Fully Extended

BOOM DEFLECTIONS NOT SHOWN

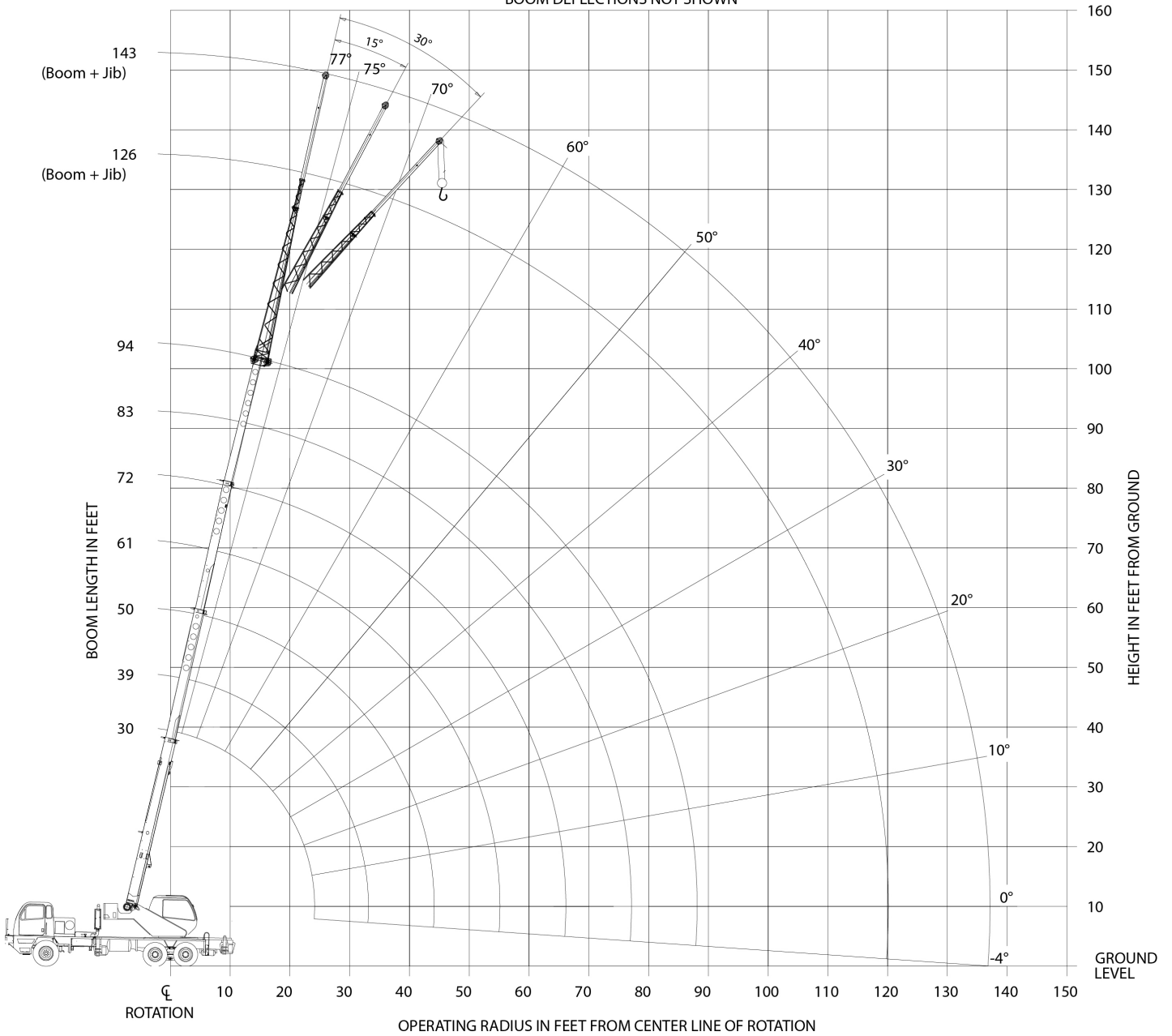

# LOAD CHART - MAIN BOOM

340-94

## Outriggers Fully Extended



Standard ASME B30.5

	Boom Length (ft)							
	30	39	50	61	72	83	94	
ft	Lb	Lb	Lb	Lb	Lb	Lb	Lb	ft
9	80,000							9
10	70,000	46,500						10
12	60,900	46,500	46,500					12
15	49,300	46,500	44,200	38,000				15
20	35,200	36,000	36,500	32,900	27,300			20
25	26,600	27,500	28,000	27,800	23,000	21,700	17,400	25
30		19,800	20,300	20,600	19,800	18,200	14,900	30
35			15,200	15,500	15,700	15,800	13,000	35
40			11,700	12,100	12,200	12,400	11,400	40
45			9,200	9,600	9,800	9,900	10,000	45
50				7,700	7,900	8,100	8,200	50
55				6,300	6,500	6,600	6,700	55
60					5,300	5,500	5,600	60
65					4,400	4,500	4,600	65
70						3,700	3,900	70
75						3,100	3,200	75
80							2,600	80
85							2,100	85

## Outriggers Fully Retracted

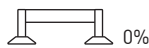

Standard ASME B30.5

	Boom Length (ft)							
	30	39	50	61	72	83	94	
ft	Lb	Lb	Lb	Lb	Lb	Lb	Lb	ft
9	35,200							9
10	28,600	29,300						10
12	20,400	21,000	21,500					12
15	13,500	14,100	14,500	14,700				15
20	7,400	8,100	8,500	8,800	8,900			20
25	4,000	4,900	5,400	5,600	5,800	5,900	6,000	25
30		2,800	3,400	3,600	3,800	3,900	4,000	30
35			2,000	2,300	2,500	2,600	2,600	35

## Notes to lifting capacity

Lifting capacities do not exceed 85% of tipping load. Weight of hook blocks and slings are part of the load, and are to be deducted from the capacity ratings. Consult operation manual for further details.

Note: Data published herein is intended as a guide only and shall not be construed to warrant applicability for lifting purposes. Crane operation is subject to the computer charts and operation manual both supplied with the crane.

# LOAD CHART - MAIN BOOM

340-94

## With Offset Jibs



Standard ASME B30.5

32 ft Offsettable Jib					
0° Offset		15° Offset		30° Offset	
ft	lb	ft	lb	ft	lb
38	9,000	46	7,600	52	5,800
42	8,500	49	7,200	55	5,700
45	8,100	52	6,900	58	5,500
50	7,300	58	6,100	63	5,000
56	6,200	63	5,400	68	4,500
61	4,900	68	4,600	73	4,100
66	4,000	73	3,900	77	3,700
73	3,400	79	3,200	83	3,000
79	2,800	85	2,500	88	2,400
86	2,200	91	2,000	94	2,000
92	1,800	97	1,600	99	1,600
100	1,300	103	1,200	105	1,200
106	800	109	800	110	800

49 ft Offsettable Jib					
0° Offset		15° Offset		30° Offset	
ft	lb	ft	lb	ft	lb
41	5,000	55	3,300	62	2,600
47	4,700	59	3,200	68	2,600
52	4,400	64	3,100	73	2,500
60	4,000	70	2,900	79	2,400
66	3,700	76	2,800	84	2,400
71	3,500	81	2,700	88	2,300
77	3,300	86	2,600	93	2,300
84	2,900	93	2,300	99	2,200
91	2,300	99	1,900	105	1,900
100	1,800	106	1,500	110	1,500
109	1,400	112	1,200	116	1,200
116	900	119	900	122	900
122	600	126	500	127	500

## On Tires

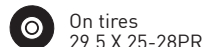
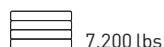

Standard ASME B30.5

Boom		Travel Speed: Boom straight over rear		
ft	ft	0 mph	Creep	2.5 mph
		lb	lb	lb
10	30	19,200	19,200	19,200
12	30	15,800	15,800	15,800
15	39	12,100	12,100	12,100
20	39	7,600	7,600	7,600
25	50	5,100	5,100	5,100
30	50	3,600	3,600	3,600
35	50	2,600	2,600	2,600
40	50	1,700	1,700	1,700







## Notes to lifting capacity

Lifting capacities do not exceed 85% of tipping load, (75% of tipping load on tires). Weight of hook blocks and slings are part of the load, and are to be deducted from the capacity ratings. Consult operation manual for further details.





Note: Data published herein is intended as a guide only and shall not be construed to warrant applicability for lifting purposes. Crane operation is subject to the computer charts and operation manual both supplied with the crane.

# TECHNICAL DESCRIPTION

## Boom

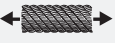
Standard configuration:		
	Full power extension via foot pedal control	4 sections
	Minimum / Maximum	30 ft / 94 ft
	Maximum tip height	102 ft
	Boom elevation angle range (min. / max.)	-4° / 77°
Optional configuration:		
	32 ft swing-on jib, fixed length	
	Angular offsets	0°, 15°, 30°
	Maximum tip height with fixed jib	134 ft
	32—49 ft swing-on two piece jib	
	Angular offsets	0°, 15°, 30°
	Maximum tip height with extended jib	151 ft
	3 or 4 metallic load sheaves Quick reeving design	
	Auxillary Head Installs only on main boom head, compatible with extendable and fixed swing-on jibs	
	2 sheave	25USt
	3 sheave	30USt
	4 sheave	40USt
	Quick reeving design	
	Top swivel ball with hook and latch	7 USt

## Main and Aux Hoist, Rope and Hook

Standard configuration:		
	Two speed ratios	
	1st layer without load (low range / high range) 5th layer without load (low range / high range)	167 ft/min / 335 ft/min 242 ft/min / 487 ft/min
	Maximum line pull	
	1st layer (low speed/ high speed) 5th layer (low speed/ high speed)	15,639 lb / 7,298 lb 10,827 lb / 5,052 lb
	Permissible line pull	9,000 lb
	6x19 IWRC XIPS	
	Rope diameter	5/8 in
	Maximum usable	455 ft



# TECHNICAL DESCRIPTION

## Cab, Controls, Operator aids and Load limiter / Load indicator

### Standard configuration:



#### Upper cab:

- Sliding door
- Sliding window on the right side
- Tilting, tinted glass skylight
- Removable front windshield
- Six-way adjustable seat with armrest dual-axis electro-proportional joysticks
- Joystick control for hoist(s), swing and boom elevation
- Foot pedals for swing brake, boom telescope and engine rpm
- Hand control for engine rpm

#### Lower cab:

- Hinged door with roll-down window
- Sliding window on the right side
- Six-way adjustable seat with seatbelt
- Cruise control
- Two speed windshield wiper with washer



Electronic rated capacity indicator with color display

### Optional configuration:



#### Upper cab:



- Air conditioning – hydraulically powered
- Heater and air conditioning package – hydraulically powered
- Liquid Propane (LP) Cab Heater
- Single-Axis armrest mounted controls
- Work Lights
- Upper cab remote carrier control
- AM/FM radio with cassette

#### Lower cab:

- Jacobs engine brake

# TECHNICAL DESCRIPTION



## Superstructure

Standard configuration:		
	Glide swing with foot pedal actuated multi-disc brake and air actuated house lock	360°
	Hydraulic driven double planetary reduction gear drive	2.5 rpm

## Tires



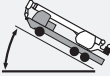

Standard configuration:		
	Aluminium wheels with stainless hub covers	
	Front Tires	445/65 R22.5
	Rear Tires	11 R22
Optional configuration:		
	Pusher Axle	11 R22.5

## Vehicle performance

Standard configuration:		
	Theoretical maximum grade	
	Manual transmission	56%
	Automatic transmission	64%
	Maximum speed	60 mph

# TECHNICAL DESCRIPTION

## Carrier, Engine and Drive-line

Standard configuration:	
	Turn radius to centerline of tires <span style="float: right;">34 ft</span>
	Axle drive system <span style="float: right;">6 x 4 drive</span> Air brakes with ABS, Air release / spring set
	Engine and transmission, EPA 2017 compliant, CARB 2017 certified Cummins L-9 Intake: Turbocharger with intercooler Rated power <span style="float: right;">8.9 L / 300 hp @ 2,000 rpm</span> Eaton Fuller 10-speed manual transmission Fuel type: Diesel
	Fuel tank capacity <span style="float: right;">60 gallon</span>
	Voltage <span style="float: right;">12 VDC</span> 2 Batteries <span style="float: right;">1,000 CCA each</span> Alternator <span style="float: right;">130 amp</span>
Optional configuration:	
	Engine and transmission, EPA 2017 compliant, CARB 2017 certified Cummins L-9 Intake: Turbocharger with intercooler Rated power <span style="float: right;">8.9 L / 300 hp @ 2,000 rpm</span> Allison 7-speed automatic transmission with lock-up torque converter Fuel type: Diesel

[www.loadkingmfg.com](http://www.loadkingmfg.com)

